

KANTON  
**URI**

Baudirektion

Amt für Tiefbau, Abteilung Wasserbau

Gemeinde Sisikon/UR, Morschach/SZ, Riemenstalden/SZ

Objekt Hochwasserschutz Riemenstaldnerbach  
M2 - Ersatzneubau Brücke Kirchenweg, 18t Nutzlast

Gewässer Riemenstaldnerbach

Planart **Situation 1 : 100**  
Querschnitte / Längsschnitt 1 : 50 / 20

Phase Bauprojekt Beilage:

Masstab	Planformat	Plan - Nummer	
1:100 / 50 / 20	60 x 90	Kanton Uri 691/693 - 2.1c	Ingenieurbüro 2.1c
Projektverfasser:			
A. Zwysig Ingenieurbüro AG 6452 Sisikon mail@ing-zwysig.ch Tel: 041 820 47 65 www.ing-zwysig.ch Fax: 041 820 47 43		Datum	Gez.
		- 25.03.2015	NZ
		a 20.04.2015	NZ
		b 29.06.2015	NZ
		c 01.10.2015	NZ



**LEGENDE:**

- best. Vorplatz
- neue Betonplatte
- neue Brückenplatte
- best. Belag
- Belagsanpassung
- Geländer

**Nutzlast:  
2-Achs - LKW  
18 to Gesamtgewicht**

**Situation 1 : 100**

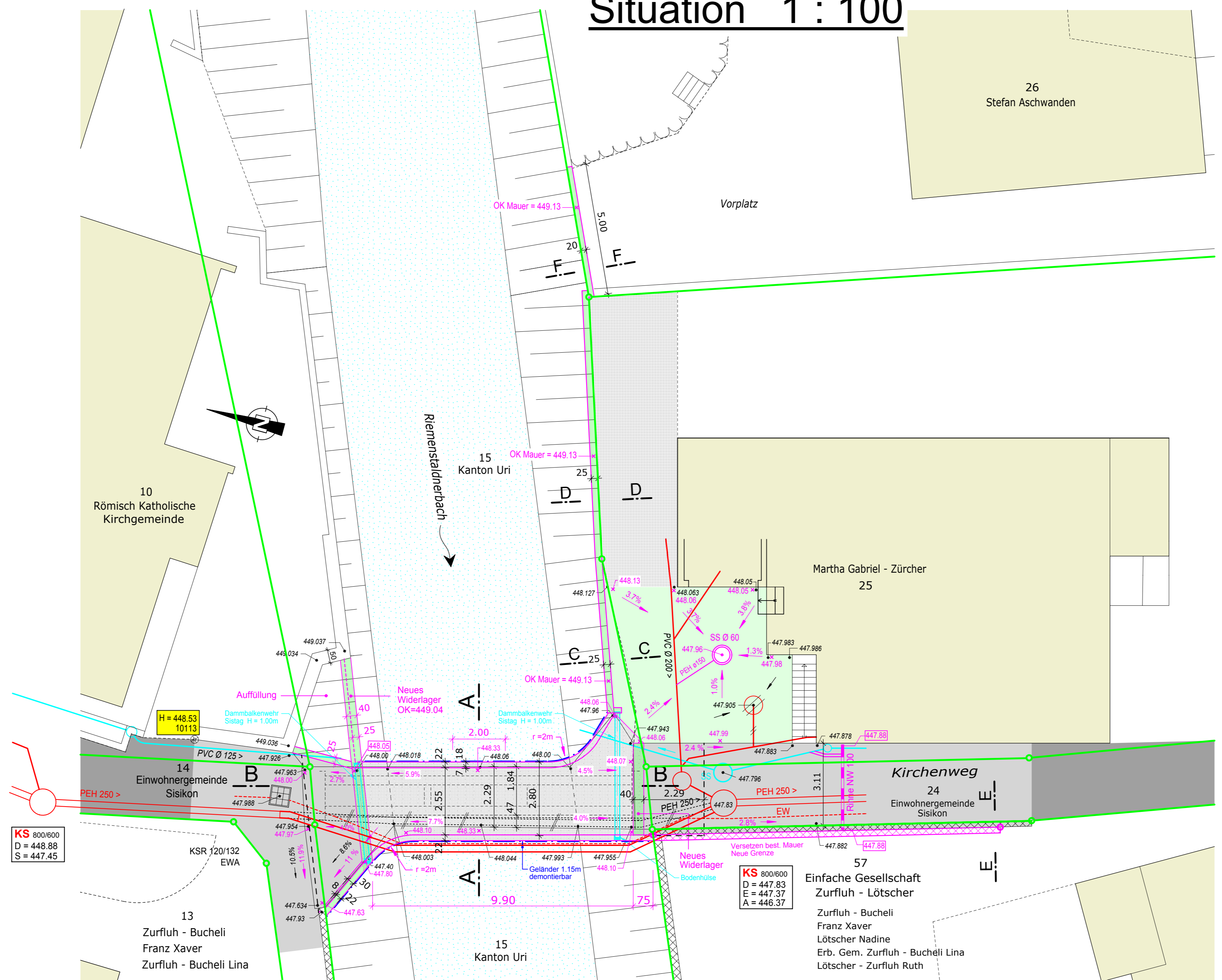

**C - C 1:20**

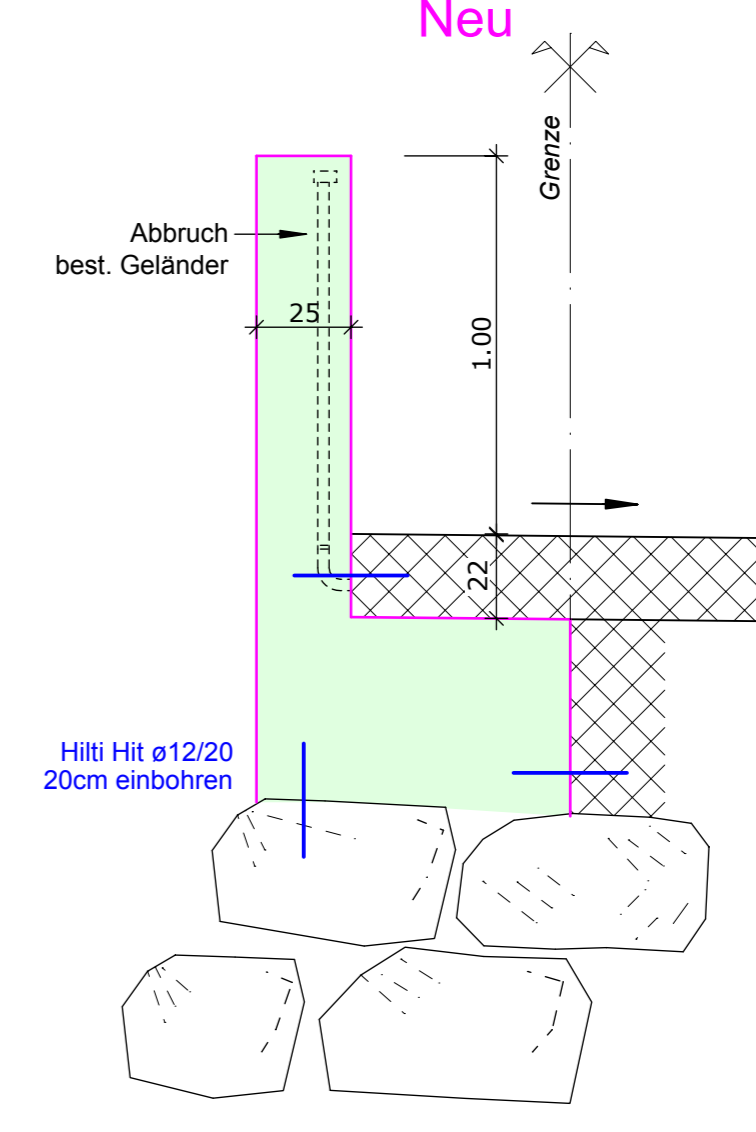

**D - D 1:20**

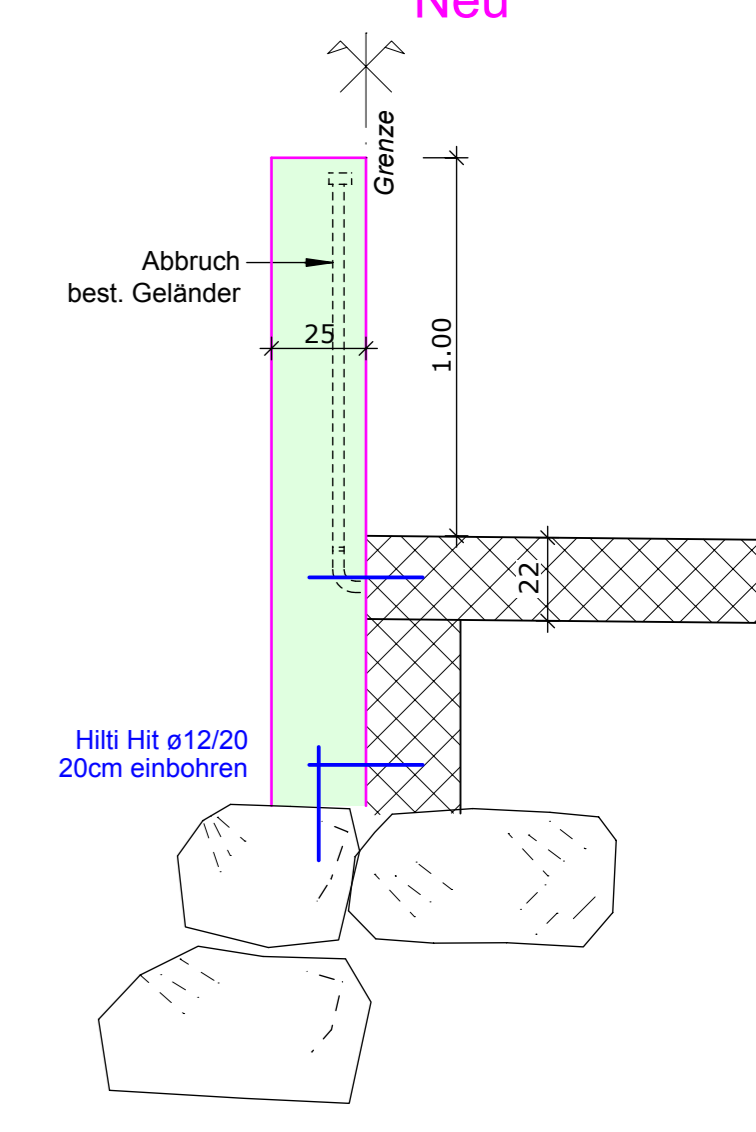

**E - E 1:20**

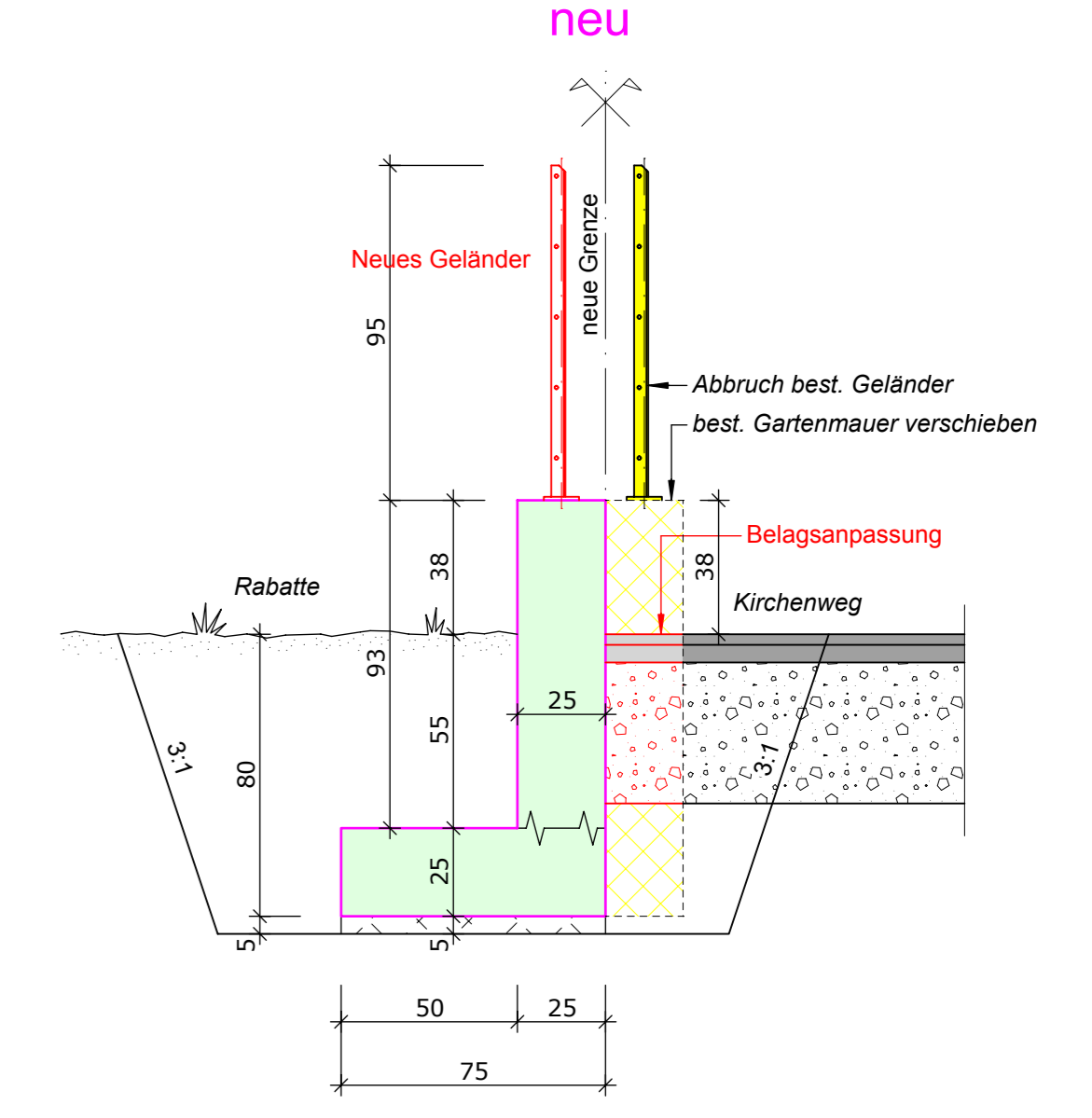

**Schnitt A - A 1:20**

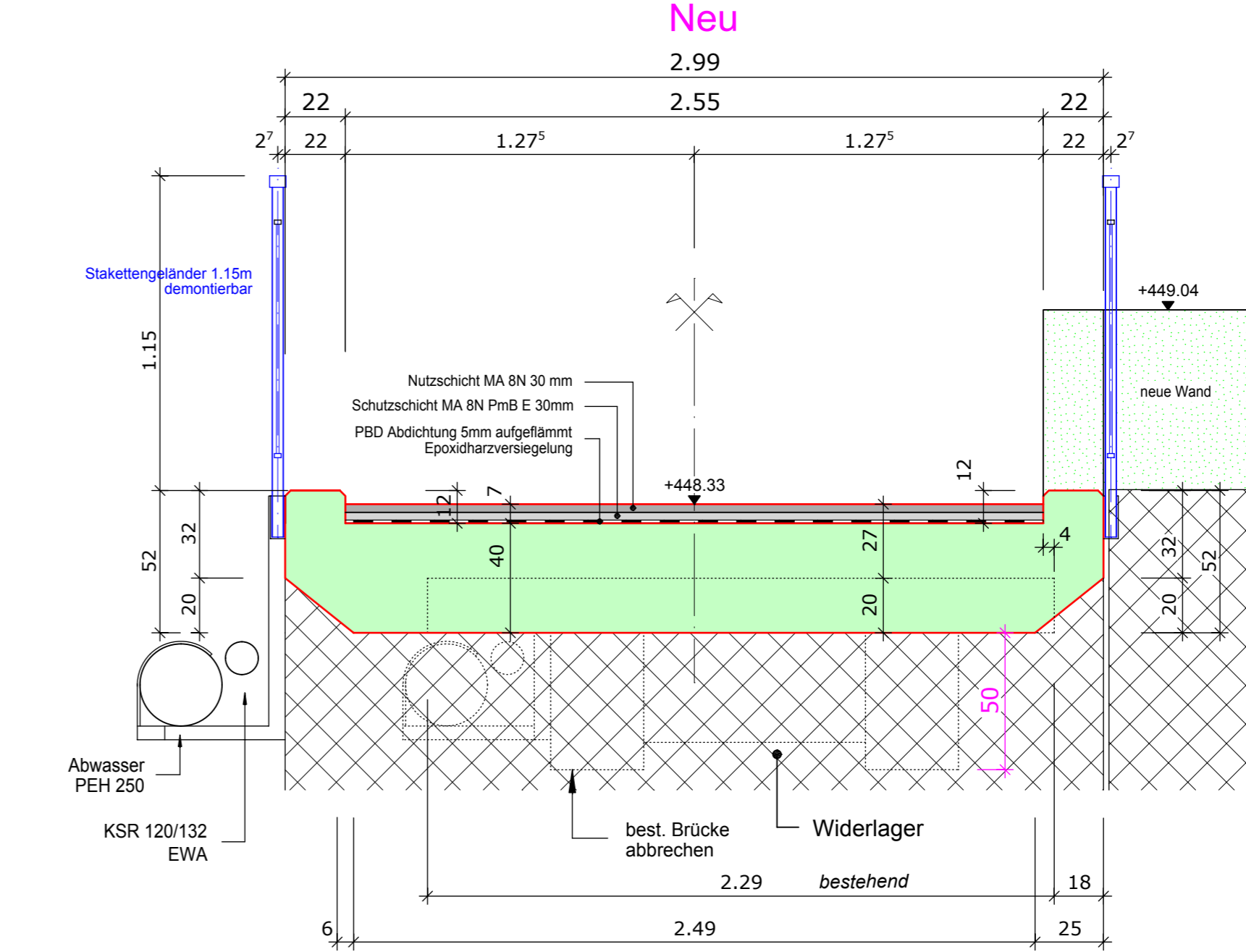

**F - F 1:20**

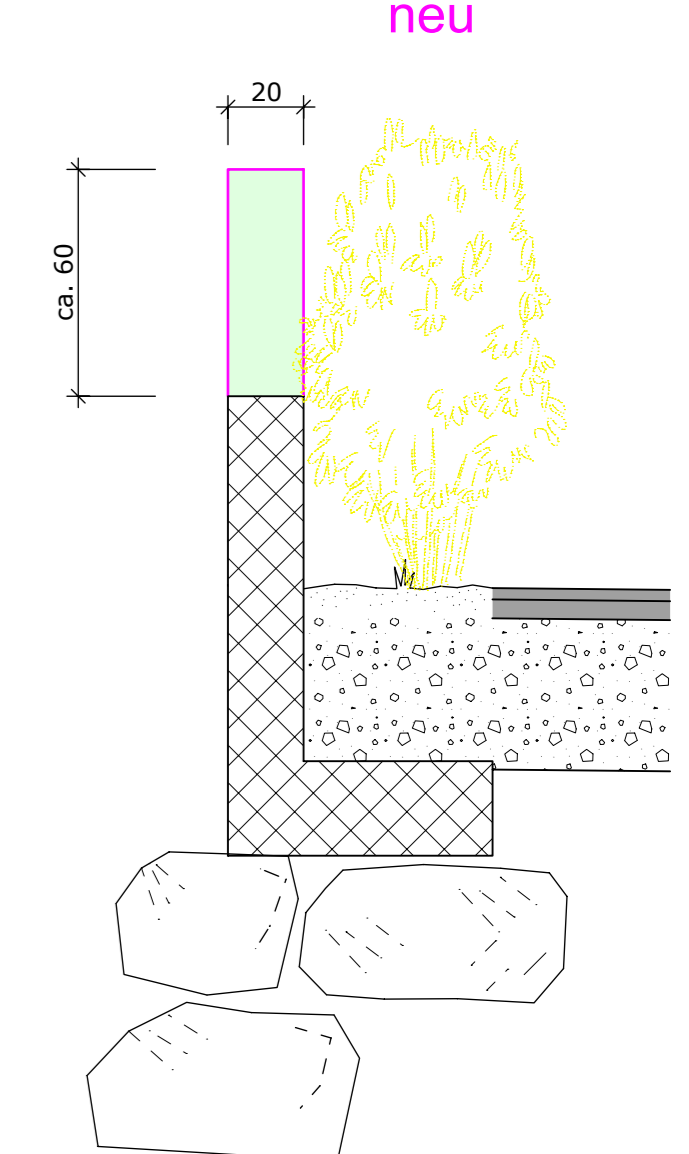

**Längsschnitt B - B 1:50**

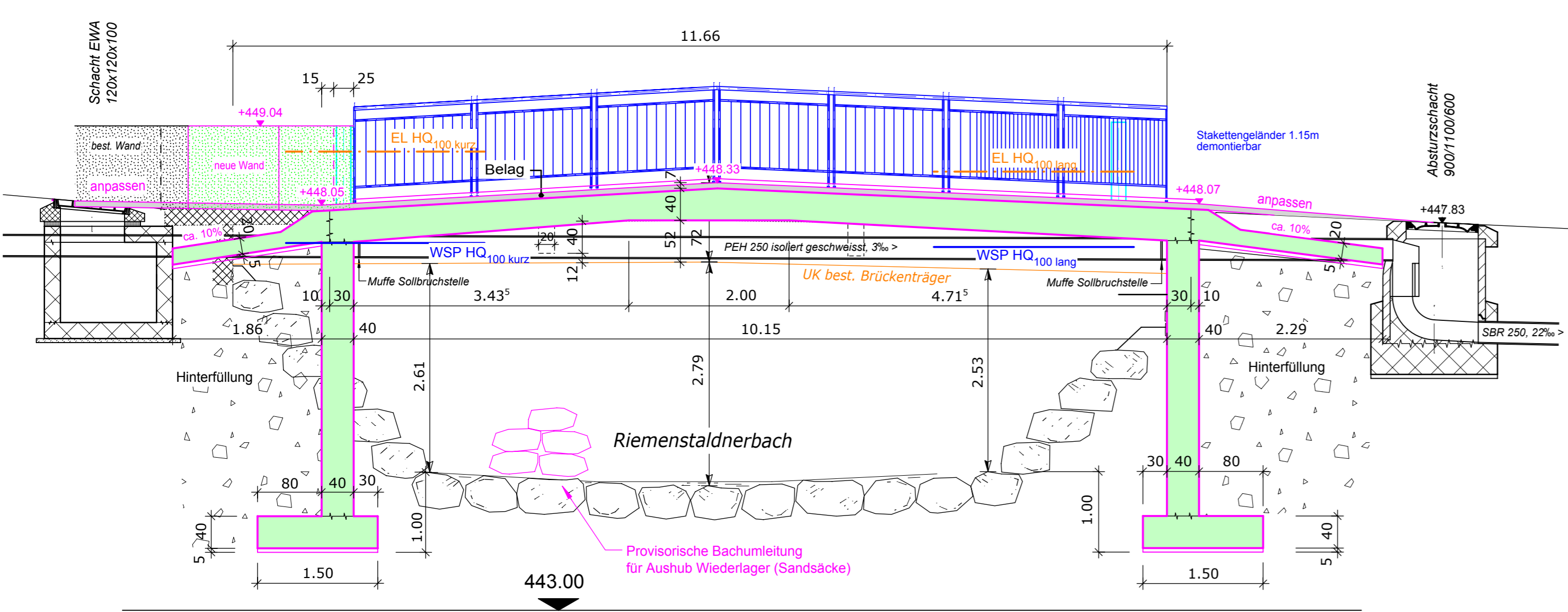

**Schnitt A - A 1:50**

